

6 x

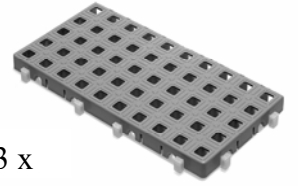

3 x

2 x



Kit - 3 =

4 x



2 x



13 x

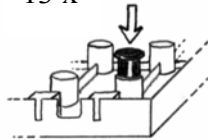

13 x
R-Lock



13 x
T-Lock



1

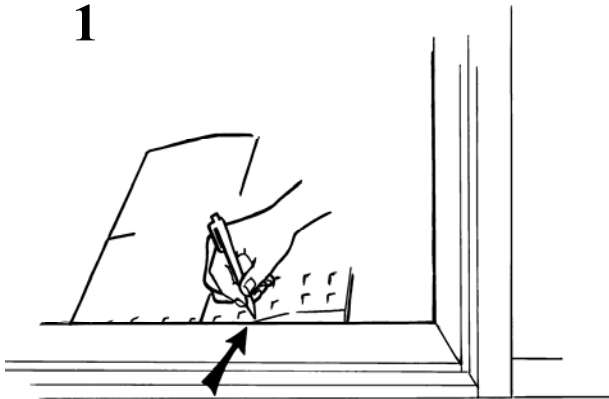

2

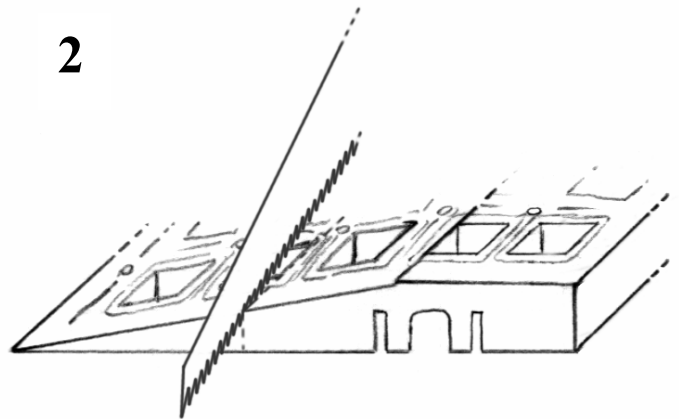

2a

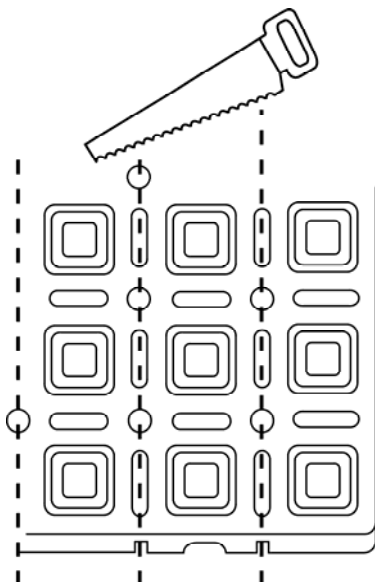

2b

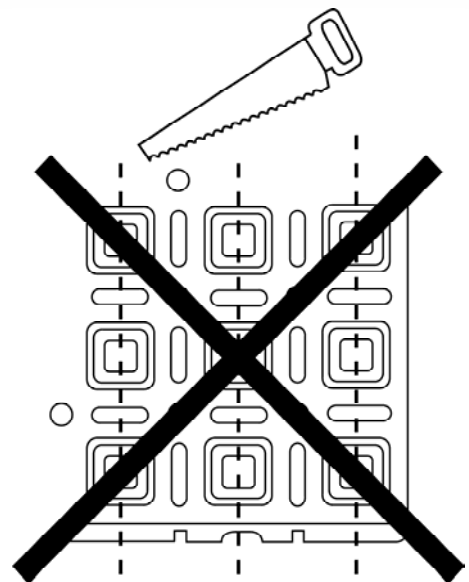

3

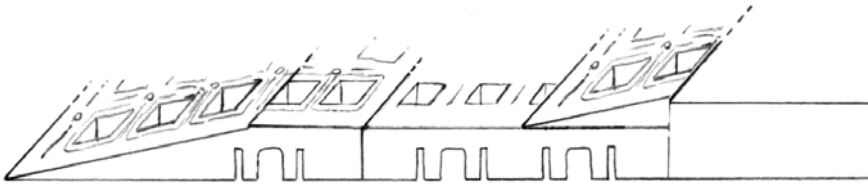

4

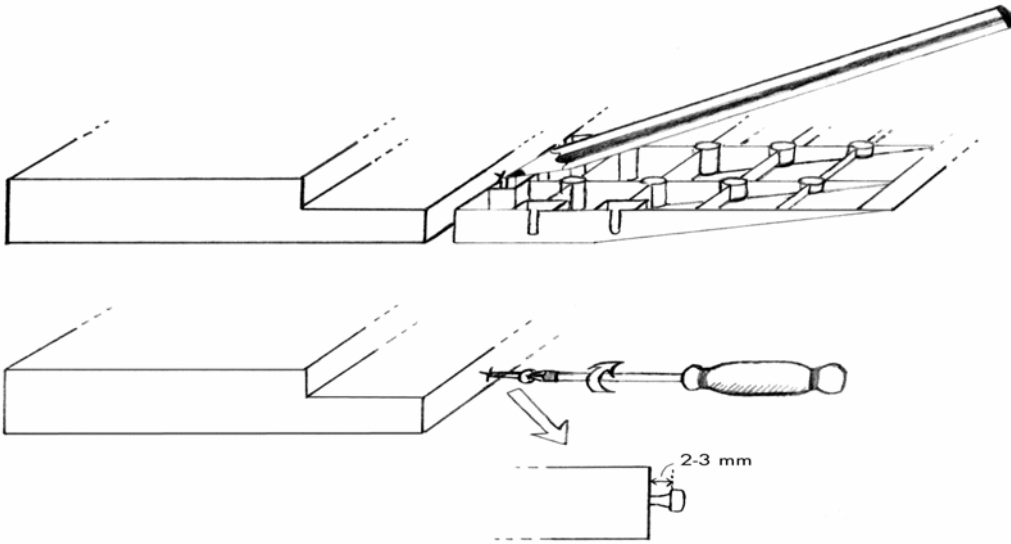

5

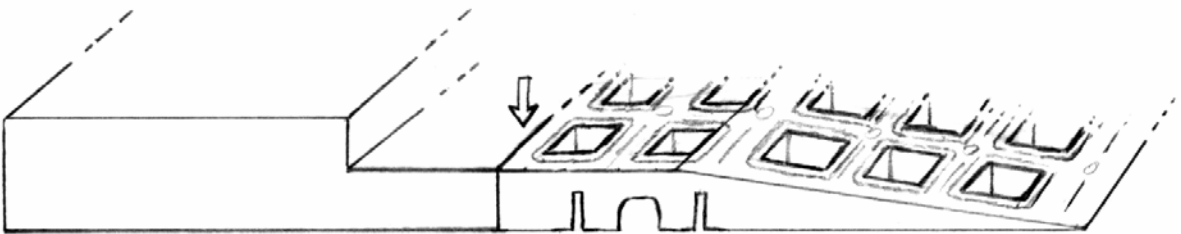

6

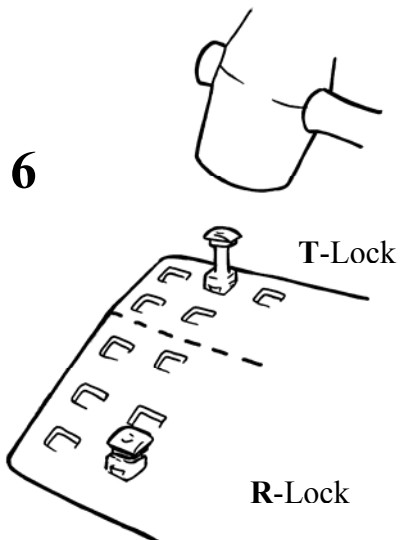

7

